



Overview

The Series 702 is a high performance external sliding commercial door offering up to 3 panels in each direction.

Key Features

- This high performance sliding door has been tested for compliance with the relevant Australian Standards. Achieved a very high water resistance of >600Pa and complied with the air-conditioning requirements of the standard.
- The extra strong multi-hollow meeting stiles allow large sliding doors to be fabricated in high wind load areas.
- There are a large variety of door combinations possible:
- XXF, FXX, XF, FX, FXF, XFF, FFX, FXXF and FXXXXF.
- 90° corner unit FX^XF and FXX^XXF also available.
- The door is compatible with the high performance Series 406 / 606 and 426 / 626 FrontGLAZE™ framing. The head and jamb sections have an additional weather leg to ensure that junctions between doors and fixed sidelights/highlights maintain the high water resistance.
- Doors can be fitted with surface mounted deadlock, mortice lock or multi point mortice lock.
- Doors run on heavy duty double bogey wheel carriages. The key to silent running door is to match the wheel diameter to the running track. This shares the dead load across the track. This is why our doors slide smooth and quiet. If required the height of the wheel can be adjusted from the edge of the panel with a standard 'Phillips' screw driver.
- Variety of bottom rail and mid rail sizes. The tall splayed bottom rail is standard as illustrated right.
- Aluminium sub-sills are available and should be used in all installations.
- Will accept glass up to 13.52mm thick single glazed or 20mm and 24mm double glazed IGU.
- Thresholds and snap-in flat filler ensure that the clean looks are maintained.
- Doors can be fitted with internal sliding or roller fly doors..

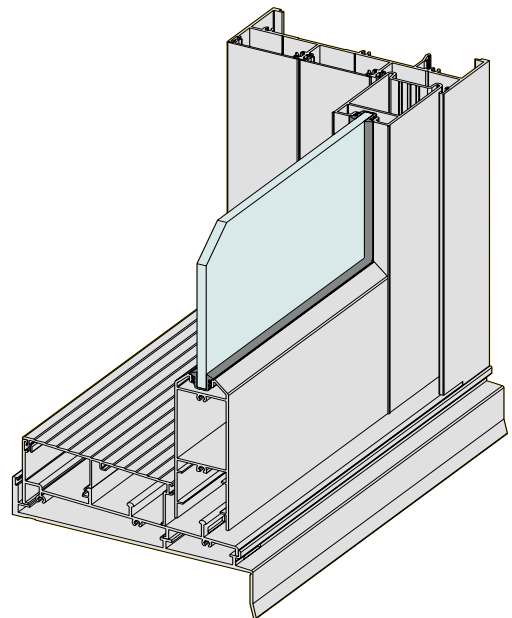

Maximum Panel Height	3000mm
Maximum Panel Width	1800mm
Maximum Glass Thickness	≤ 24mm

Subject to individual site conditions. Contact AWS Technical Support for information.



WERS RATED PRODUCT



ENHANCED ACOUSTIC PERFORMANCE



3D & 2D CAD FILES AVAILABLE



PRODUCT INFORMATION AVAILABLE AT
WWW.ELEVATEALUMINIUM.COM.AU



SPECIFIER ASSISTANCE AVAILABLE

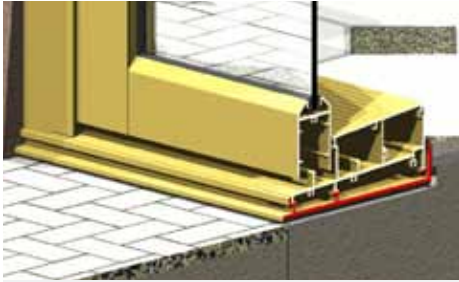

Sub-sill with central support leg, designed to suit.

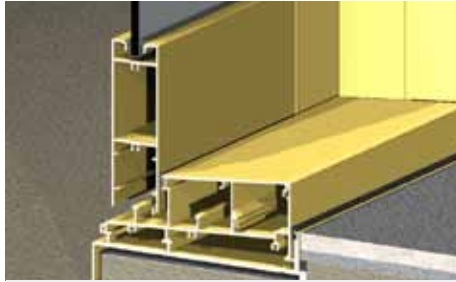

Tall, small, beveled and square rails are all an option. Tall, square rail illustrated.

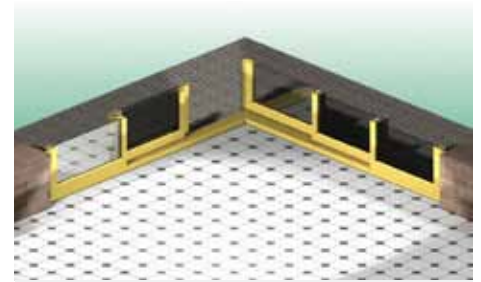

90° postless internal and external corners an option.

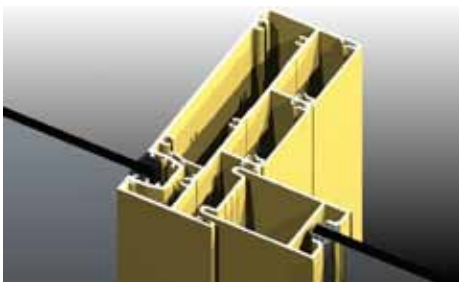

Both 100mm and 150mm compatible with most AWS Commercial suites.

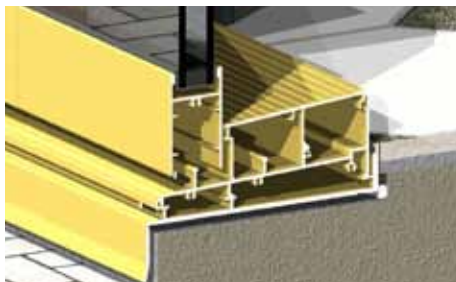

Glazing options up to 25mm double glazed unit.

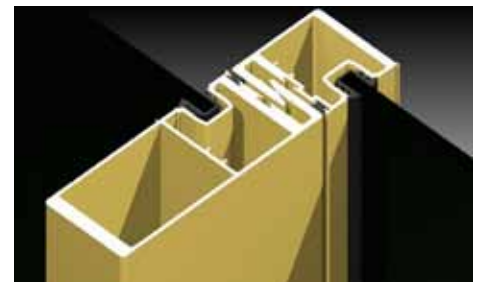

Meeting stile design changes to match required wind load.

Typical Configurations

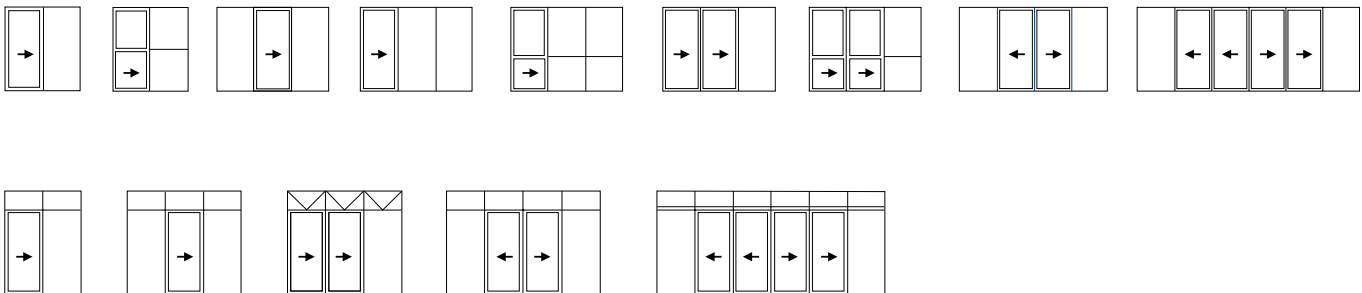

WERS RATINGS

The table below lists some of the WERS rated glass and frame combinations for this system. For a complete list of all rated glass and frame combinations refer to the Series 702 WERS Data Sheet.

Glass Description	Uw	SHGCw	T _w	Inf
6EVanClr	4.62	0.50	0.52	1.12
6EVanSpB	4.62	0.29	0.30	1.12
4/10Ar/4ET	3.28	0.56	0.58	1.12
6.38LamSpGy/12Ar/6	3.88	0.20	0.09	1.12